



API SPRAYER



API SPRAYER
ASIAN PACIFIC INDUSTRIAL LIMITED

FACTORY: 315400 YUYAO INDUSTRY ZONE, ZHEJIANG PROVINCE, CHINA

OFFICE: 321300 JINHUA CITY, ZHEJIANG PROVINCE, CHINA

WEB: [HTTPS://WWW.API-PKG.COM](https://www.api-pkg.com)

EMAIL: SALES@API-LIMITED.COM

TEL: +86-185-5790-8900

ISO9001

ISO14001

SA8000



COMPANY PROFILE

API Sprayer acquired ISO9000 & ISO14000 certification for manufacturing mechanical dispensing devices and spray pumps.

API Sprayer serves the global market with various of personal care products and solutions; cosmetics and fragrance packing solutions; household and automotive cleaning packing solutions, pharma and food solutions.

Benefit from our fully automatic assembly machines and testing devices, API Sprayer is well positioned to meet different market needs with wide product range. Our trigger sprayers, finger sprayers, lotion pumps, foam pumps, airless pumps and other packaging solution products is highly popular in global market.

With many years of OEM and designing experiences, our development center has constant energy to develop new product, explore new technology for marketplace and customer requests. Customers from Asia, USA & EU could come to us to start a special designing order with no need to go aboard. API Sprayer is bringing more and more customer projects from global top brand clients with high efficiency but low cost.

We are dedicating not only to provide the best products service, but also to offer the most competitive prices. We believe with our efficient management and highly mechanized productivity, our customers could obtain leading position and advanced competitiveness in local market.

We are expecting you to visit and joint us for further cooperation in any time.

INDEX BY PRODUCTS

	Mini Trigger 0.18 CC/0.25 CC/0.5 CC	P01-02	
	Mist Sprayer 0.15 CC/0.5 CC	P03-05	
	Crimp Mist Sprayer 0.18 CC/0.6 CC	P06	
	Perfume Sprayer 0.07 CC/0.18 CC	P07-P11	
	Powder Pump 0.03 CC/0.06 CC	P12-P13	
	Cosmetic Dispenser 0.18 CC 0.25 CC-0.5 CC (NO METAL CONTACT)	P14-P22	
	Lotion Pump 1.5 CC LEFT-RIGHT LOCK 2.0 CC SCREW DOWN 2.0 CC - 3.0 CC NO METAL CONTACT PUMP 2.5 CC ACTUATOR DIRECTION ORIENTED	3.0 CC SCREW DOWN 5.0 CC NO METAL CONTACT PUMP 10 CC NO METAL CONTACT PUMP	P23-P35
	Gallon Pump 10-30 CC	P36-P37	
	Trigger Sprayer 0.8 CC 0.9-1.1 CC	1.3 CC 1.2-1.4 CC	P38-P47
	Foam Pump 0.35-0.75 CC	P48-P49	
	Dropper	P50	
	Mini Pack	P51-54	
	Cap	P55-56	



MINI TRIGGER

ST1201 SERIES

Mini Trigger (0.18CC/0.25CC/0.5CC)

This mini trigger with dosage 0.18cc/0.25cc/0.5cc per stroke delivers exceptional spray performance for lighter home and garden applications and personal care as well. An integrated lock between head and closure ensure that product is safe during shipping and storage.



OUTPUT 0.5CC

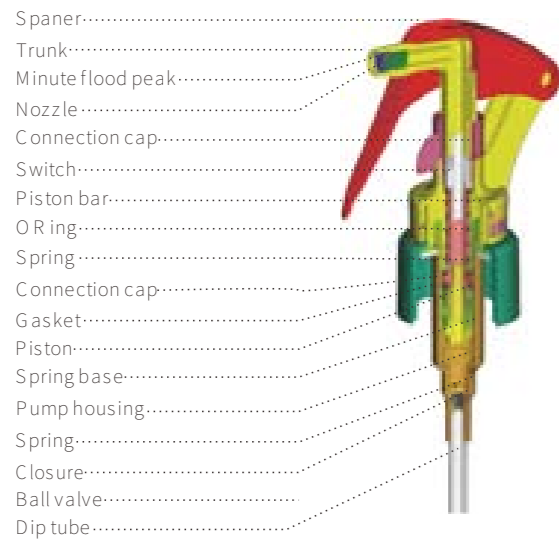

OUTPUT 0.18CC

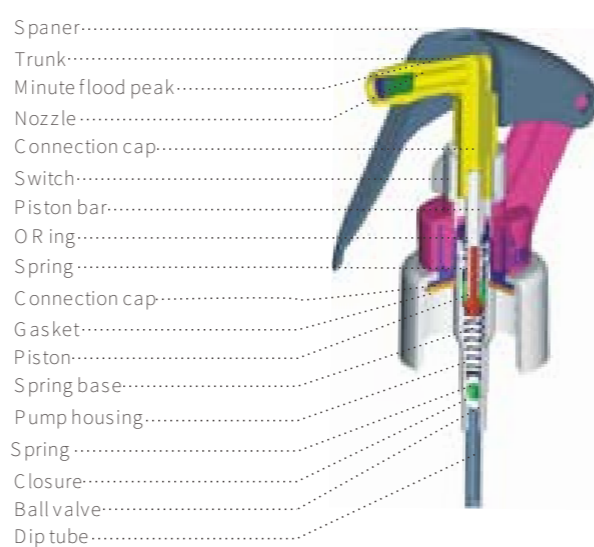

0.18CC OUTPUT



ST1201



ST1208

0.25CC OUTPUT



ST1204



ST1205

0.4-0.5CC OUTPUT



ST1203



ST1206



ST1207

CLOSURE



24/410 RIBBED



24/410 SMOOTH



24/415 SMOOTH



24/415 RIBBED



28/410 RIBBED



28/410 SMOOTH



MIST SPRAYER

ST3002 SERIES

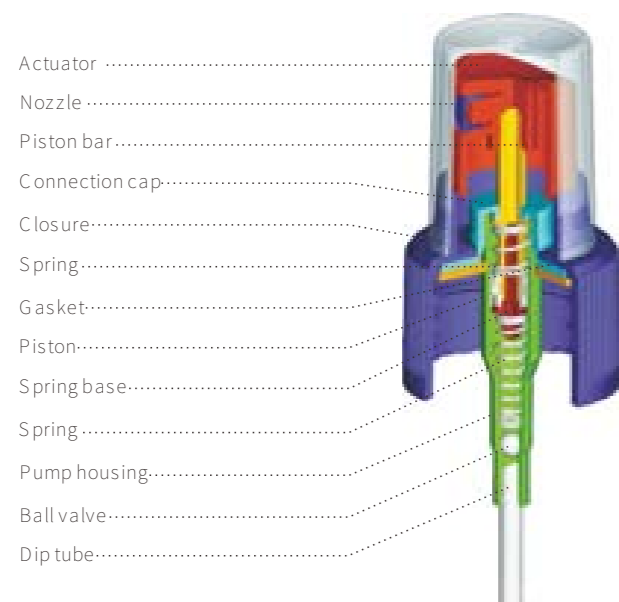

Compatibility

Compatibility testing is recommended if there are questions or concerns API Sprayer offers complete laboratory testing assistance and provides recommendations to assist customers with their final packaging decision.

CLOSURE



OTHERS





MIST SPRAYER

ST3210 SERIES

NO METAL CONTACTN 0.5CC



24/410



28/410

OTHER



METAL COLLAR FOR OPTION

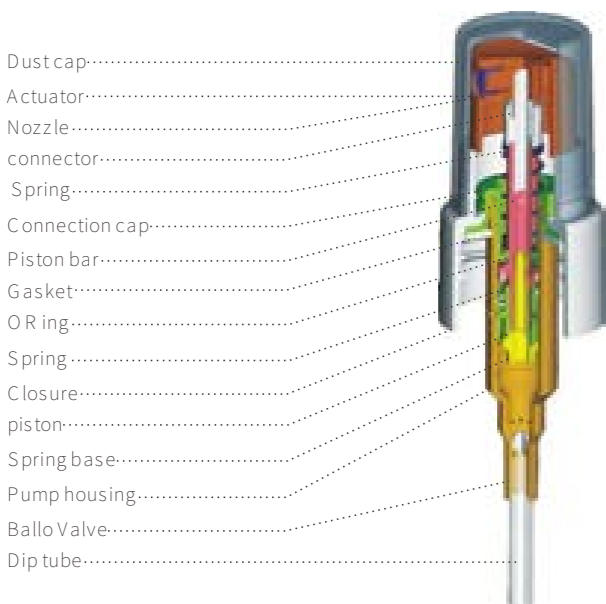

Compatibility

Compatibility testing is recommended if there are questions or concerns API SPR AYER offers complete laboratory testing assistance and provides recommendations to assist customers with their final packaging decision.

CRIMP MIST SPRAYER

ST3035 SERIES

ONE INCH

OUTPUT 0.18 CC



ST3035



ST3036

OUTPUT 0.6 CC



ST3037 NO METAL CONTACT

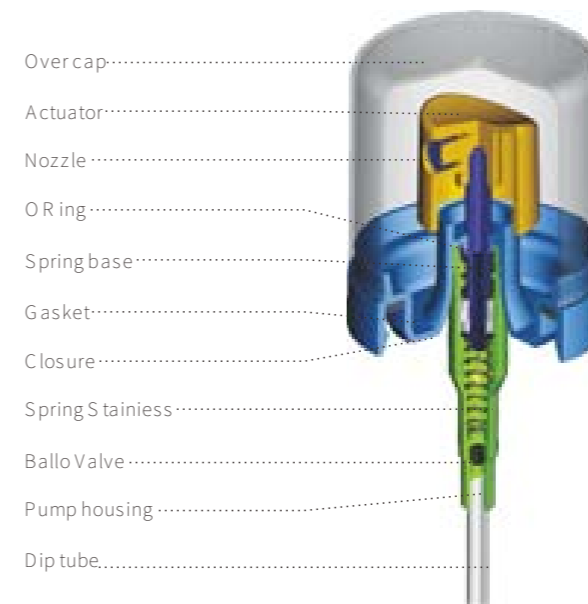



PERFUME SPRAYER

ST3010 (0.15CC/0.18CC)

Our crimp mist sprayer is available in range of FEA15,18,20mm closure dimensions, normal and low profile and 0.15cc/0.18cc output for options.

To avoid carelessly depression of the actuator, we offer plastic safety clip of options.

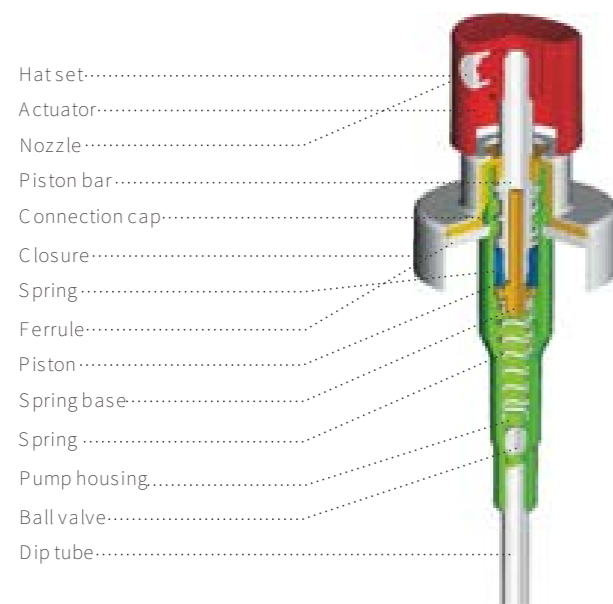

OUTPUT 0.15CC

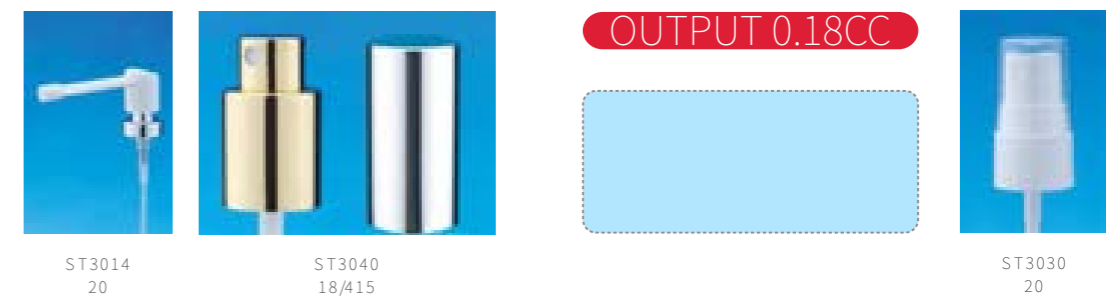

OUTPUT 0.18CC





PERFUME SPRAYER

ST3020/ST3070.07CC LOW PROFILE

Our crimp mist sprayer is available in range of FEA13,15,18,20mm closure dimensions, normal and low profile and 0.07cc output for options.

To avoid carelessly depression of the actuator, we offer plastic safety clip of options.

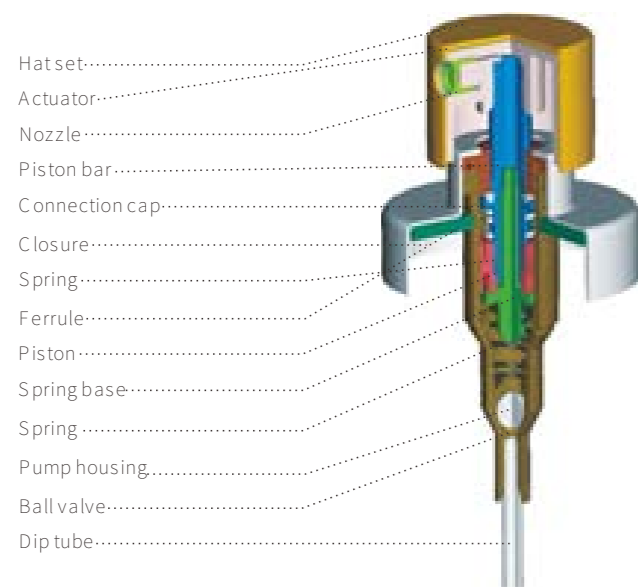

- Hat set.....
- Actuator.....
- Nozzle.....
- Piston bar.....
- Connection cap.....
- Closure.....
- Spring.....
- Ferrule.....
- Piston.....
- Spring base.....
- Spring.....
- Pump housing.....
- Ball valve.....
- Dip tube.....

Compatibility

Compatibility testing is recommended if there are questions or concerns. API SPRAYER offers complete laboratory testing assistance and provides recommendations to assist customers with their final packaging decision.

CRIMP



ST3020
13



ST3020
15



St3020
18



ST3020
20



ST3021
13



ST3021
15



ST3021
18



ST3021
20



ST3020
CRIMPIESS
AVAILABLE SIZE:15/20



ST3020
FEA15
PLASTIC CRIMP



ST3020
EU4(SCREW)
AVAILABLE 20/400(SCREW)





ST 307

LOW PROFILE PERFUME SPRAYER 0.07CC

CRIMP



13 15 18 20

SCREW



EU4 18/400 18/410 20/400 20/410

CRIMPLESS

(NO GASKET)



P13FEA P15FEA P18FEA P20FEA

OPTION



PLASTIC ACTUATOR METAL ACTUATOR CAP1 CAP2

POWDER PUMP

FOR CRIMP BOTTLE NECK

Diameter 13mm & 20mm

Output 0.006g

Aluminium closure



ST6002 13MM CRIMP PUMP

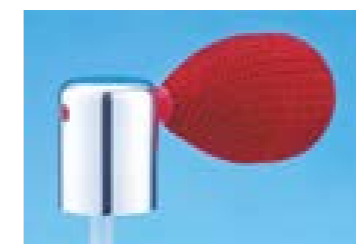

ST6006 20MM CRIMP PUMP

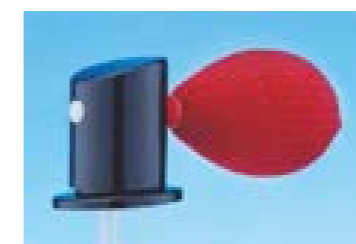

ST6007 13MM CRIMP PUMP

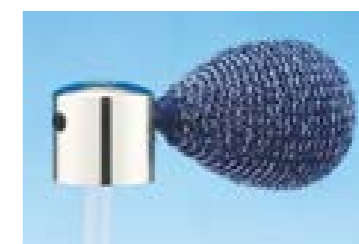

ST6009 15M CRIMP PUMP

PERFUME PUMP

FOR SCREW BOTTLE NECK

Closure 18/410
 Output 0.03ml
 Aluminium closure
 Long hose and tassel for option



ST6004C 18/410



ST6004A 18/410



ST6004B 18/410

COSMETIC DISPENSER

0.18CC

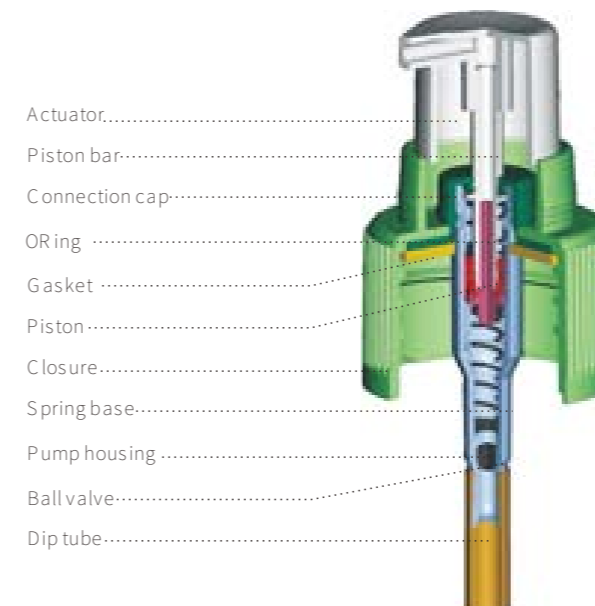

Compatibility

Compatibility testing is recommended if there are questions or concerns. API SPRAYER offers complete laboratory testing assistance and provides recommendations to assist customers with their final packaging decision.

COSMETIC DISPENSER

0.18CC



ST4050 20/410

ST4051 20/410

ST4056



20/410RIBBED

20/410SMOOTH

20/415RIBBED

24/410SMOOTH



24/410RIBBED

22/415RIBBED

24/415RIBBED

ST40562



20/410 SMOOTH

20/410 RIBBED

20/415 RIBBED

22/415 RIBBED



24/410SMOOTH

24/410RIBBED

24/415RIBBED

METAL COLLAR FOR OPTION

ST40563



24/410

METAL COLLAR FOR OPTION

COSMETIC DISPENSER

0.25CC 0.5CC

NO METAL CONTACT

ST40564



2 0/410SMOOTH



2 0/410RIBBED



2 0/415RIBBED



2 2/415RIBBED



24/410SMOOTH



24/410RIBBED



24/415RIBBED



ST405820/410



ST405920/410



ST406020/410



ST406218/41020/410



ST4057220/410



Compatibility

Compatibility testing is recommended if there are questions or concerns. API SPRAYER offers complete laboratory testing assistance and provides recommendations to assist customers with their final packaging decision.

1. Replaces the ball bottom valve
2. Airless or atmospheric
3. Very efficient for viscous and thick and sticky formulations

OUTPUT 0.25CC

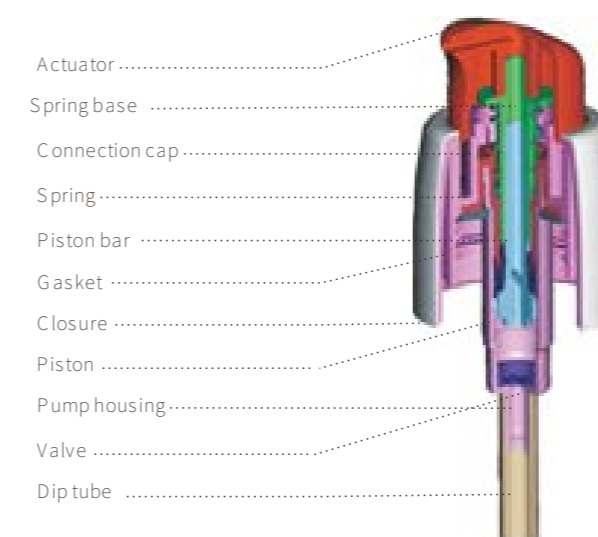

OUTPUT 0.5CC

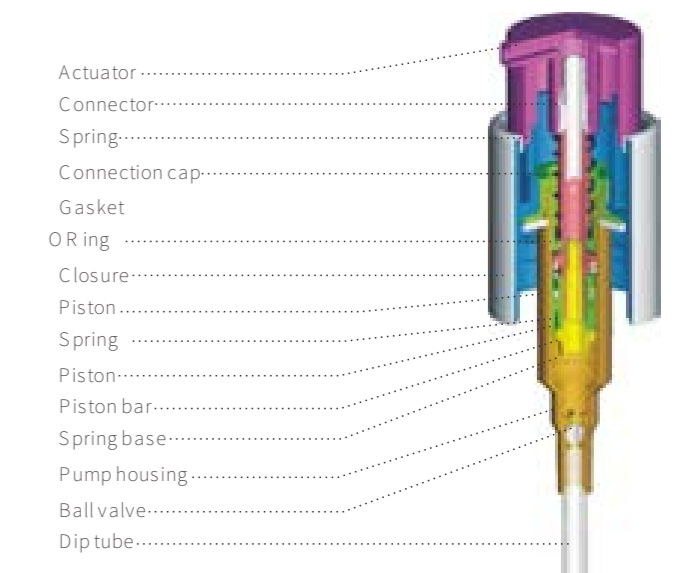

0.25CC COSMETIC DISPENSER

ACTUATOR



ST415A

OTHERS



OVERCAP

CLOSURE FOR OPTION



18/400

ACTUATOR



ST415B

OTHERS



OVERCAP

CLOSURE FOR OPTION



20/410



22/410GA2

ACTUATOR



ST415D



ST415H



ST415I



ST415K

CLOSURE FOR OPTION



18/400

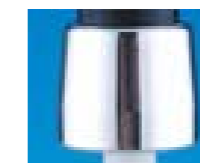

18/400 METALCOLLAR



20/410



20/410 METALCOLLAR



18/400



18/400 METALCOLLAR

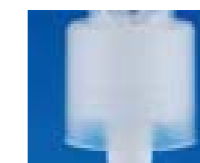

18/415



18/415 METALCOLLAR



20/410

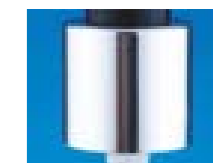

20/410 METALCOLLAR



0.5CC COSMETIC DISPENSER NO METAL CONTACT

ACTUATOR



ST415L



ST415M

CLOSURE FOR OPTION



18/400



18/400 METAL COLLAR



20/410 SMOOTH



20/410RIBBED



20/410 METAL COLLAR



24/410RIBBED



24/410 METAL COLLAR

OTHERS



OVERCAP ONLY AVAILABLE FOR 18/400



OVERCAP

ACTUATOR



ST416D



ST416H



ST416I



ST416L



ST416M

CLOSURE FOR OPTION



24/410-1



24/410-2



24/410-3



24/410-4

LOTION PUMP

LEFT-RIGHT LOCK 1.5CC

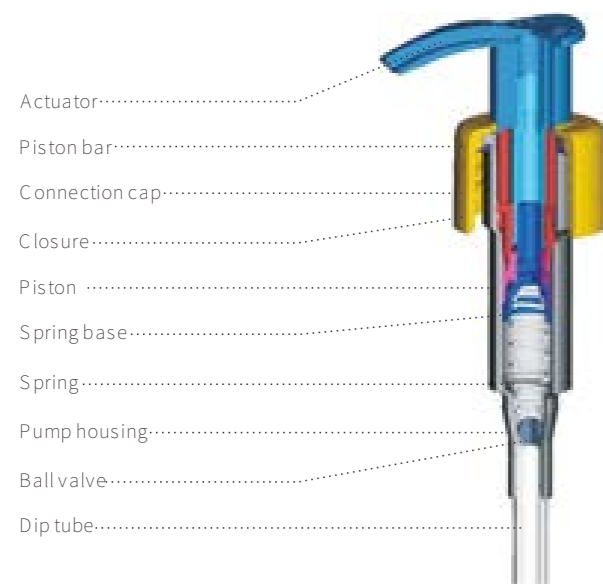

Compatibility

Compatibility testing is recommended if there are questions or concerns. API SPRAYER offers complete laboratory testing assistance and provides recommendations to assist customers with their final packaging decision.

ACTUATOR



ST4012 ST40122 ST40123 ST40124 ST40125

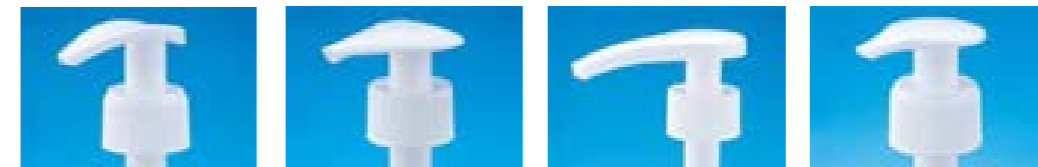

ST40126 ST40127 ST40128 ST40129

CLOSURE



24/410RIBBED 24/410SMOOTH 24/415RIBBED 24/415SMOOTH 28/400



28/410RIBBED 28/410SMOOTH 28/410H 28/410H-2 28/415

OTHERS



Lock A Lock B

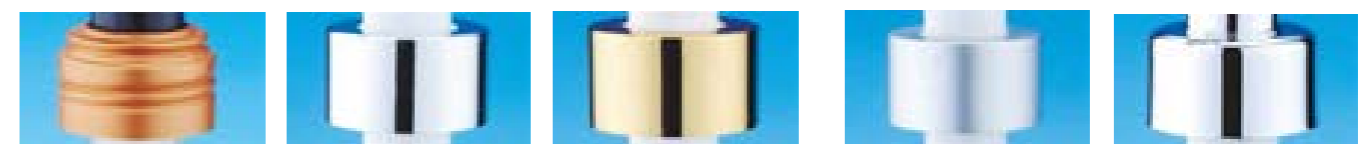

METAL COLLAR FOR OPTION



LOTION PUMP

SCREW DOWN LOCK 2.0CC



ACTUATOR



ST4011



ST4011A



ST4013



ST4014



ST4015



ST4018



ST4019



ST4017



ST4017-2

CLOSURE



24/410 RIBBED



24/410 SMOOTH



24/415 RIBBED



28/400



28/405



28 Ratchet



28/410 RIBBED



28/410 SMOOTH



BPF



28/415 RIBBED



28/415 SMOOTH

OTHERS



METAL COLLAR FOR OPTION

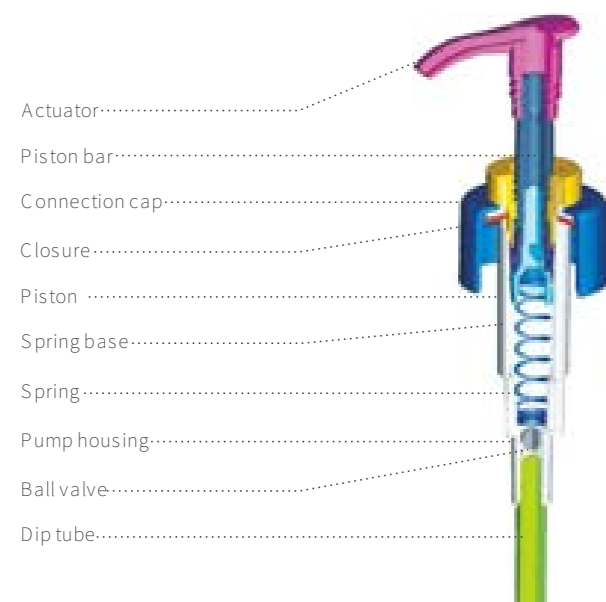

Compatibility

Compatibility testing is recommended if there are questions or concerns. API SPRAYER offers complete laboratory testing assistance and provides recommendations to assist customers with their final packaging decision.

NO METAL CONTACT PUMP

SCREW DOWN LOCK
(2.0CC-3.0CC)

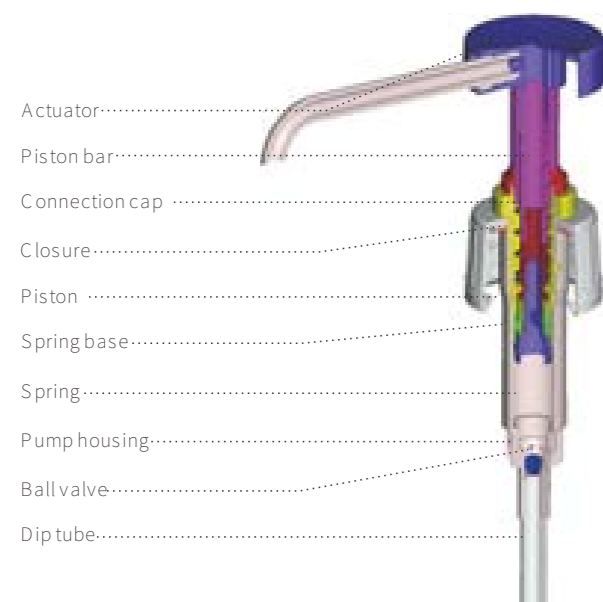

Compatibility

Compatibility testing is recommended if there are questions or concerns. API SPRAYER offers complete laboratory testing assistance and provides recommendations to assist customers with their final packaging decision.

ACTUATOR

2.0CC

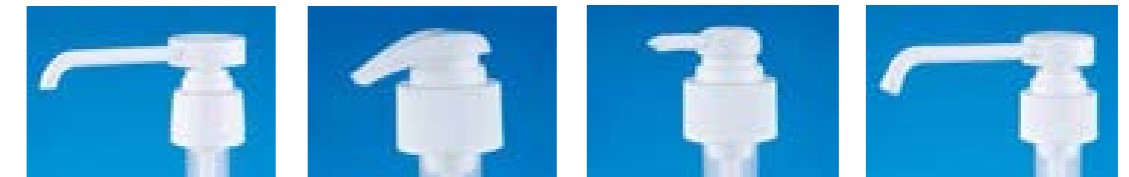

ST4100 ST4101 ST4102 ST4103

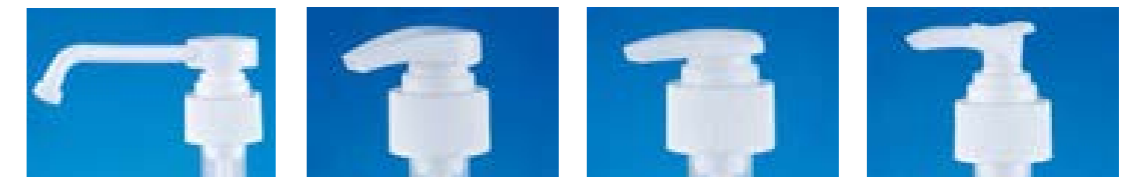

ST4103-2 ST4104 ST4105 ST4107

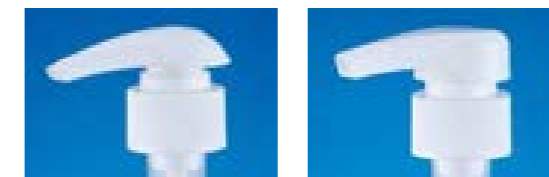

ST4108 ST4109

ACTUATOR

3.0CC

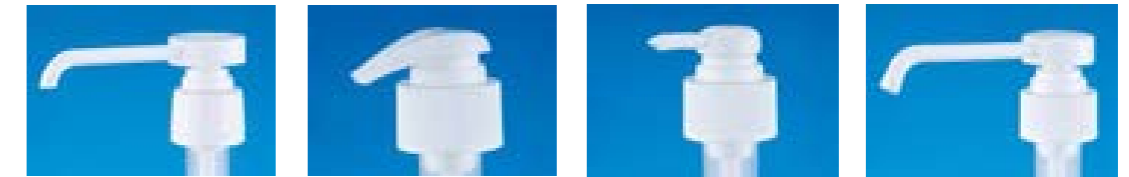

ST4110 ST4111 ST4112 ST4113

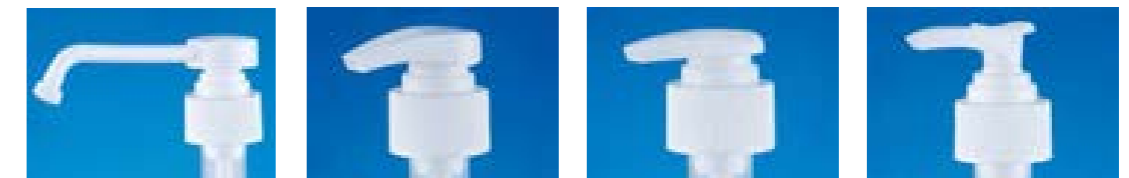

ST4113-2 ST4114 ST4115 ST4117

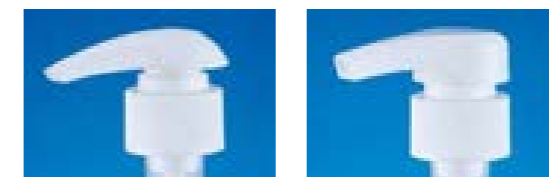

ST4118 ST4119



CLOSURE



24/410 RIBBED

24/410 SMOOTH

24/415 RIBBED



28/400

28/405

28/410 RIBBED



28/410 SMOOTH

BPF

28/415 RIBBED



28/415 SMOOTH

28 RATCHET

28 TAMPEREVIDENT

OTHERS

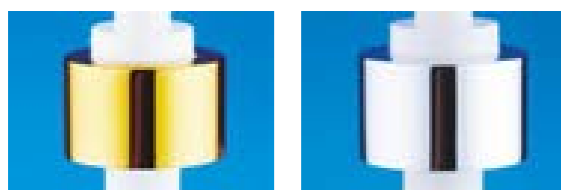

METAL COLLAR FOR OPTION

NO METAL CONTACT PUMP

LEFT-RIGHT LOCK 2.0CC

ACTUATOR

2.0CC



ST4120



ST4122



ST4124



ST4125

CLOSURE



24/410 Ribbed



24/410 Smooth



24/415 Ribbed



28/410 Ribbed



28/410 Smooth



28/415 Ribbed

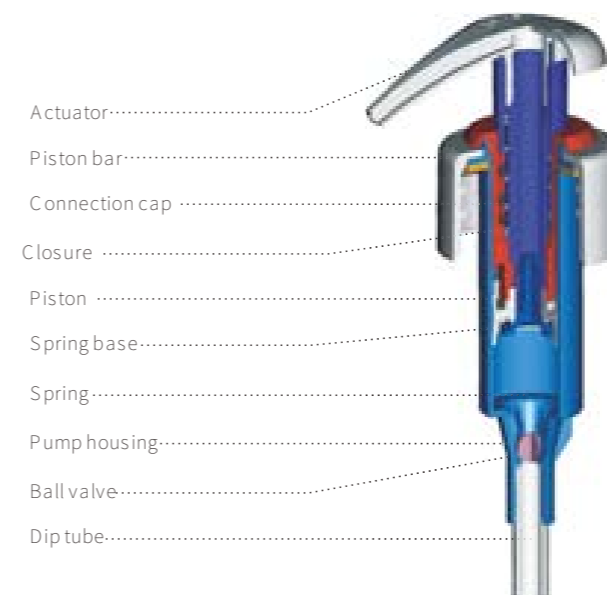

Compatibility

Compatibility testing is recommended if there are questions or concerns. API SPRAYER offers complete laboratory testing assistance and provides recommendations to assist customers with their final packaging decision.



LOTION PUMP

ST4030

Big dosage 2.3-2.5cc
Actuator direction oriented

ACTUATOR 2.3-2.5 CC



ST4030

CLOSURE



28/410RIBBED

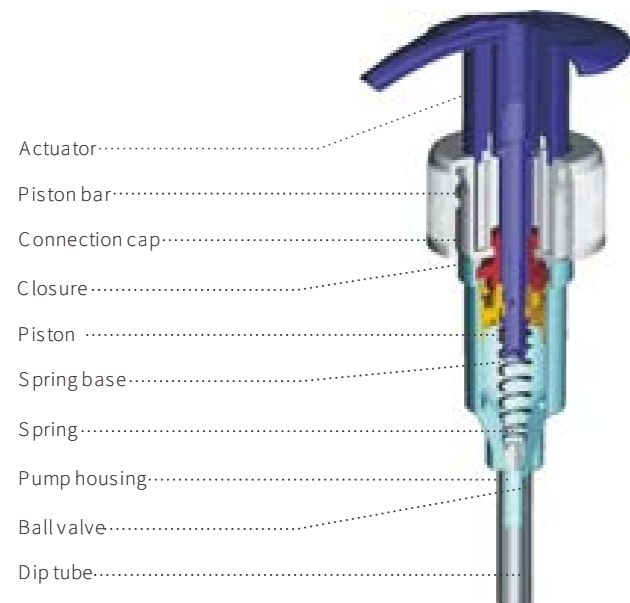

Compatibility

Compatibility testing is recommended if there are questions or concerns. API SPRAYER offers complete laboratory testing assistance and provides recommendations to assist customers with their final packaging decision.

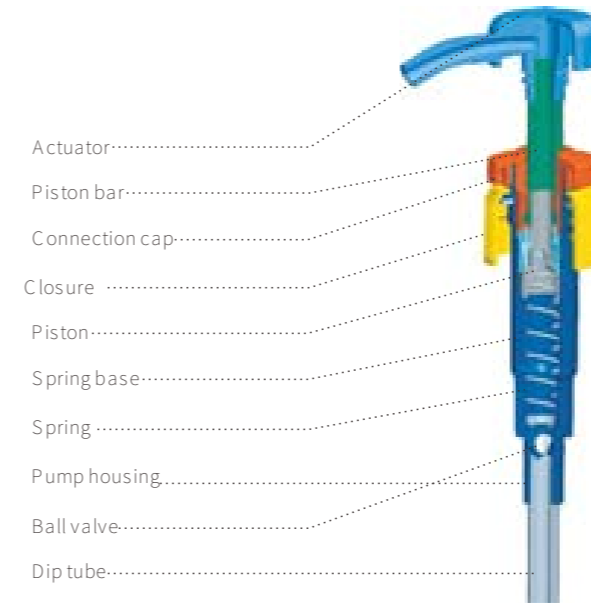

LOTION PUMP

ST4020

Big dosage 3.0-3.5cc
ST4020 lotion pump is for big dosage application like shampoo, conditioners and body washes.

CLOSURE



28/410



33/410



38/400



38/410

ACTUATOR 3.0-3.5 CC



ST4020

OTHERS



OVERCAP

NO METAL CONTACT PUMP

SCREW DOWN LOCK (5CC / 10CC)

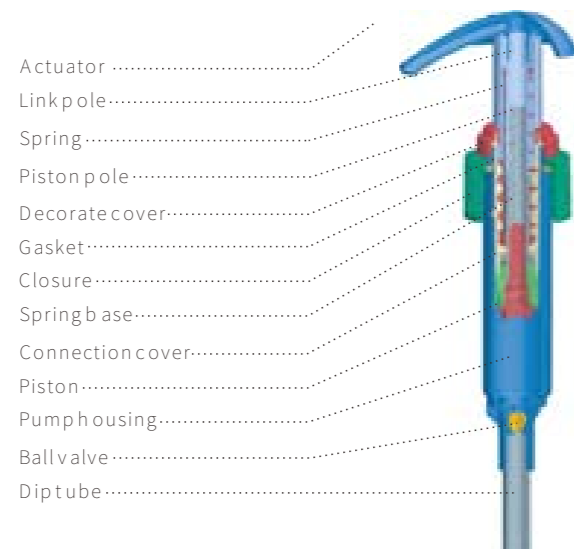

OUTPUT 5CC



ST4130



ST4131



ST4132



ST4133



ST4134



ST4135
WITH ANTI-DRIPPPING VAVLE

CLOSURE



28/400



28/410



33/400



38/400 RATCHET



40/400 RATCHET

OUTPUT 10CC



ST4140



ST4141



ST4142



ST4143



ST4144



ST4145
WITH ANTI-DRIPPING VALVE

CLOSURE



28/400



28/410



31/410



33/400



38/400



38/410



38/400 RATCHET



40/400 RATCHET

GALLON PUMP

ST4040 (10CC 15CC 20CC 25CC 30CC)

Screw down lock head configuration prevents “pop-up” during shipment.

ST4040 series with dosage 10ml/15ml/20ml/25ml/30ml and deliver consistent, reliable performance across a full range of applications.

This series pump are designed to work with various high-output formulations, including liquid soaps, lotions, shampoos

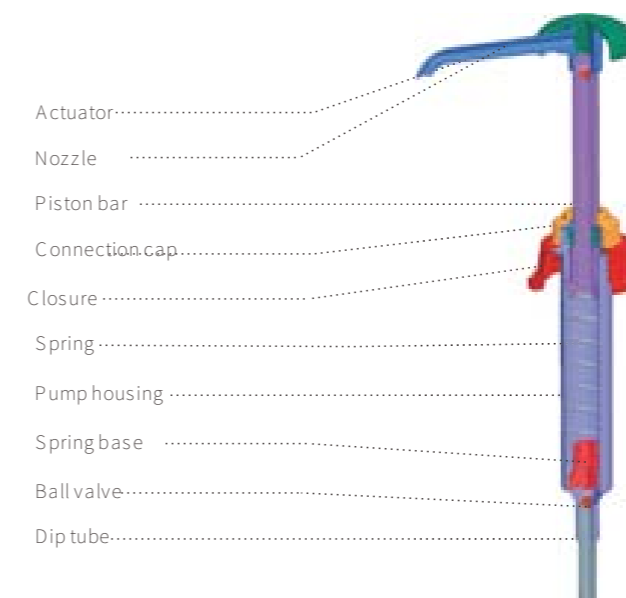

ACTUATOR



ST4040



ST4041



ST4042 WITH ANTI-DRIPPING VALVE

CLOSURE



38/400



38/410



43/400



45/400

OUTPUT



10ml



15ml



20ml



25ml



30ml

OTHERS



PRINTING FOR OPTIONS

TRIGGER SPRAYER

ST105 SERIES 0.8CC

Different mechanical instruction can prevent dip tube move up and down while trigger priming. This design could help customer to use liquid completely.

Its stable reliability and also available for a variety of applications with household, automotive, garden, industrial and personal care products.

Customize spray-steam-foam nozzle configuration, as well as many kinds of shrouds and closures.

Compatibility

Compatibility testing is recommended if there are questions or concerns. API SPRAYER offers complete laboratory testing assistance and provides recommendations to assist customers with their final packaging decision.

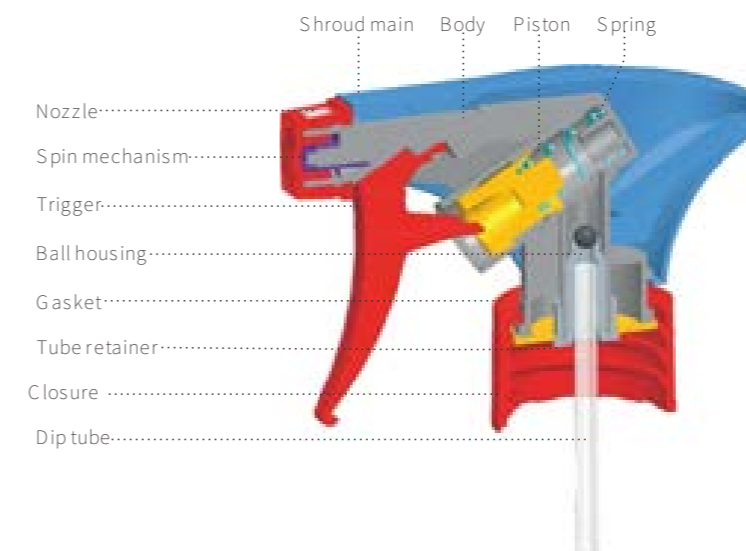

SHROUD



ST1050

ST1051

ST1052



ST1053

ST1054

ST1055



ST1056

ST1059

ST106 SERIES 0.9CC



CLOSURE



28/DIN

28/400

28/410

28/415

CLOSURE

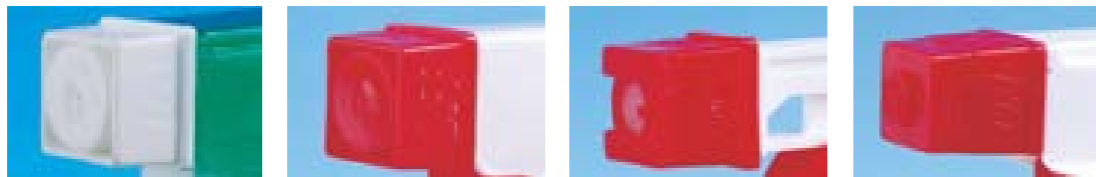

SPRAYS TREAM

SPRAY ONLY

SPRAY FOAM

MESH FOAMER

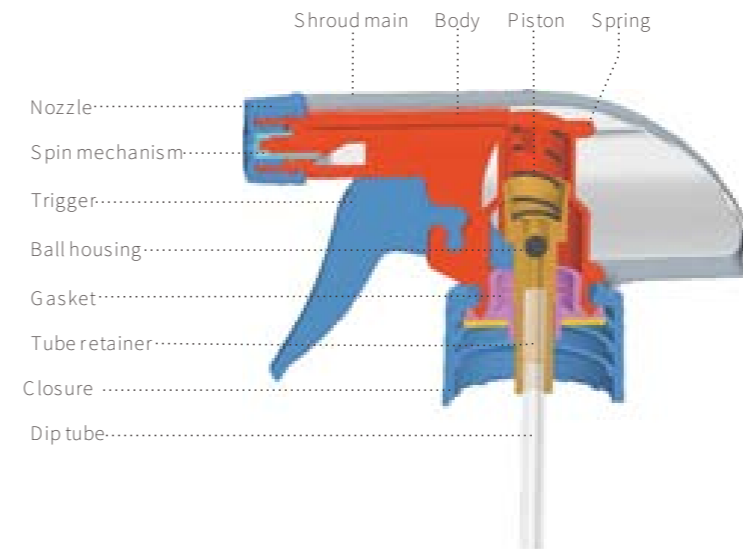

Compatibility

Compatibility testing is recommended if there are questions or concerns. API SPRAYER offers complete laboratory testing assistance and provides recommendations to assist customers with their final packaging decision.



TRIGGER SPRAYER

ST107 SERIES 1.3CC

They are perfect for a wide range of applications including lawn, garden and laundry. In addition to the standard configuration, the ST1072 ST1074 Remote with weighted tube end, which can be more convenient for using. Big dosage 1.3CC per stroke

Compatibility

Compatibility testing is recommended if there are questions or concerns. API SPRAYER offers complete laboratory testing assistance and provides recommendations to assist customers with their final packaging decision.

SHROUD



CLOSURE

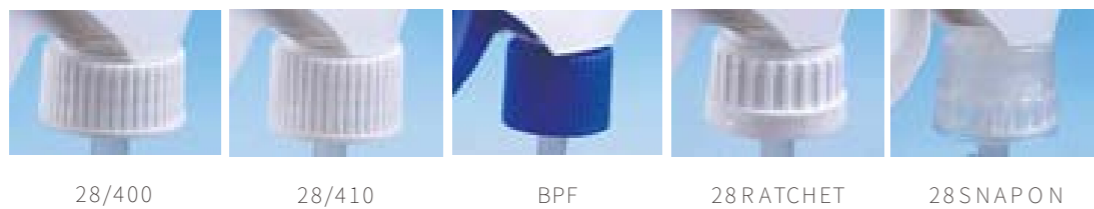

NOZZLE OPTIONS



OTHERS



SHROUD

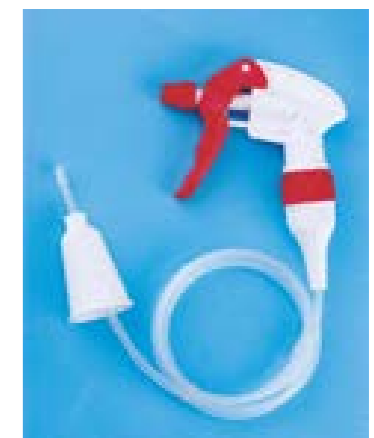
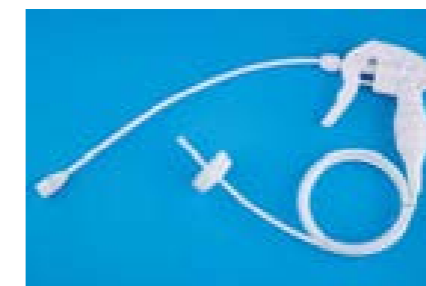

CLOSURE



TRIGGER SPRAYER

ST1010 SERIES (0.9CC/1.1CC)

They are perfect for a wide range of applications including lawn, garden and laundry. With an adjustable nozzle, these triggers can offer spray and stream function. In addition to the standard configuration, the ST1031 can be fit with brass nozzle for long term using.

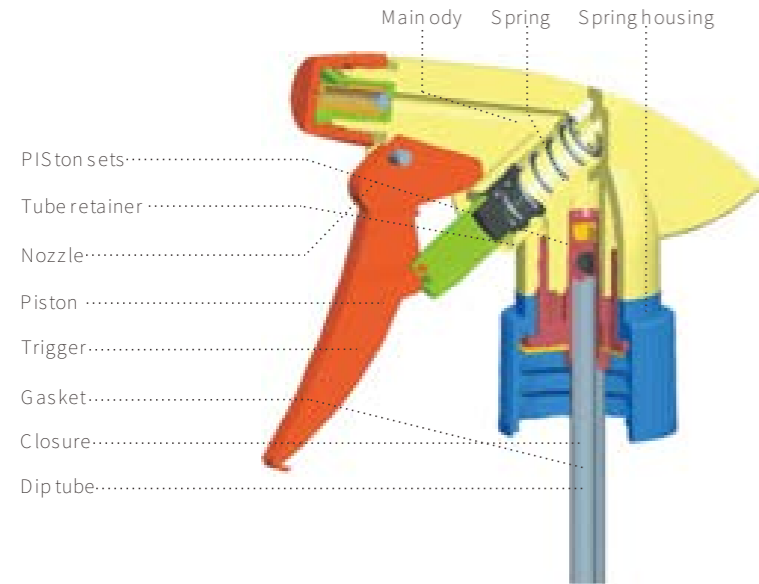

Compatibility

Compatibility testing is recommended if there are questions or concerns. API SPRAYER offers complete laboratory testing assistance and provides recommendations to assist customers with their final packaging decision.

SHROUD



ST1010 1.1CC



ST1030 0.9CC



ST1031 1.1CC



ST1040 0.9CC

CLOSURE



28/400



28/400

NOZZLE



ADJUSTABLE NOZZLE



BRASS NOZZLE



FOAM NOZZLE



TRIGGER SPRAYER

TR3000 SERIES (1.2CC/1.4CC)

This is new design in our company. The wide smooth-pull trigger combines a compact stroke with big output performance.

They are perfect for a wide range of applications including lawn, garden and laundry.

The various large nozzles provide spray/stream, spray only, spray/foam, spray brush and child resistant for added safety.

Combined with different shroud bring you modern look that greater performance on a wider range.

In addition to the standard configuration, the TR3100 Remote, which can be sprayed for long distance, is also available for a variety of applications.

New Electric Trigger Sprayer is designed now with rechargeable, constant spray and adjustable spray pattern these advantages is more and more popular in the application including garden and automotive area. Every set have one 28/400 Conversion Cover, provided 28/400 bottle to match.

Compatibility

Compatibility testing is recommended if there are questions or concerns. API SPRAYER offers complete laboratory testing assistance and provides recommendations to assist customers with their final packaging decision.

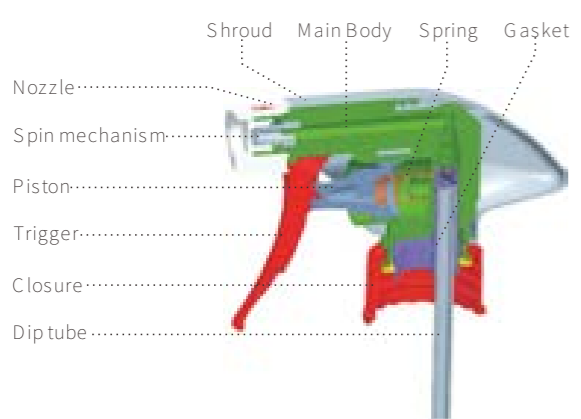

SHROUD 1.4CC



BRUSH TRIGGER



TR3000



TR3001



TR3002



TR3100



TR3003 CHILD RESISTANT

ELECTRIC TRIGGER SPRAYER

SHROUD 1.2CC



TR341 ALL PLASTIC



TR342 28SNAPON



TR343



28/400/33/410



ACTUATOR



28/400



28/410



28RATCHETA

NOZZLE OPTIONS

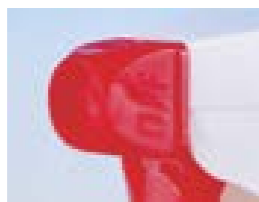

SPRAY ONLY-1



SPRAY STREAM



SPRAY ONLY-2

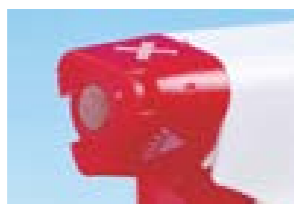

MESH FOAM -1



MESH FOAM -2



MESH FOAM -3

OTHERS



T RIGGERA

FOAM PUMP

ST5001 SERIES (0.35CC/0.75CC)

The unique air-and-liquid mixing system used. Foamer gently dispenses your product into the rich foam consumers expect. For a better life, a n easier environment. Many kinds of head and closure for options.



0.35CC



ST500128/410



ST500230/400



ST500330/400

0.75CC

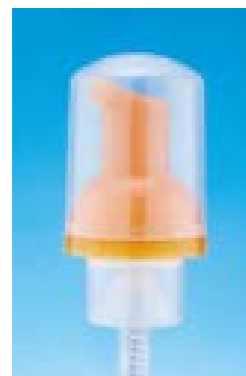

ST501040/400



ST501240/400



ST501340/400



ST501440/400



ST501540/400



ST501640/400

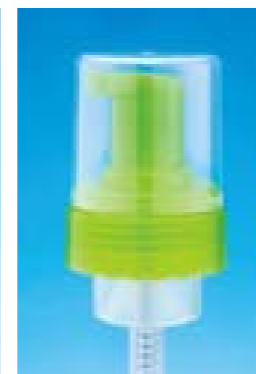

ST501143/400

DROPPER

For better life and environment
Many kinds of tube length and closure for options

CLOSURE



18/415-1



18/415-2



18/415-3



18/415-4



18/400



20/400



20/410



QT-4005-18/400 PLASTICTUBE

OPTIONS



METAL COLLAR



POINTED HEAD



ROUND HEAD



SMOOTH BUBBLE



MATT BUBBLE



XXS-MINI PACK

For better life and environment.
 Glass vial and plastic vial are available
 Many kinds of volume and color for options

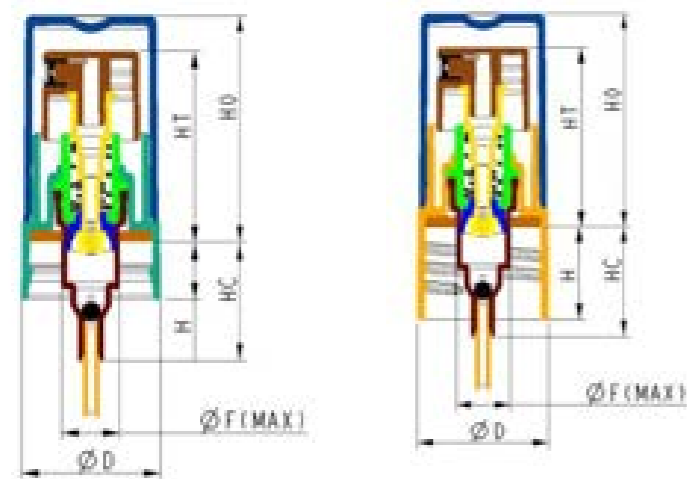

SNAP ON

SCREW

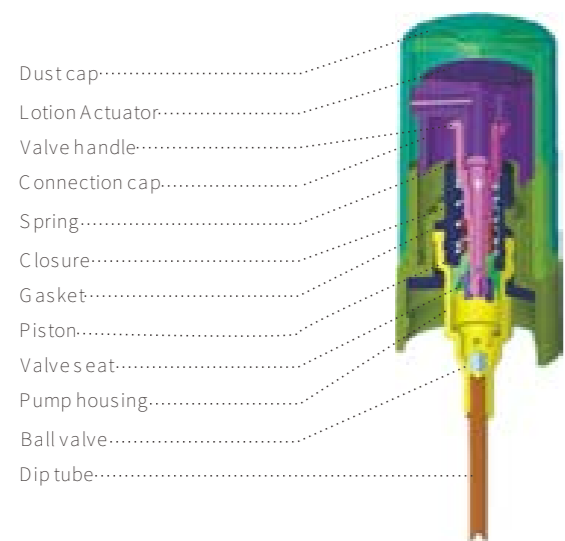

L OTIONA CTUATOR

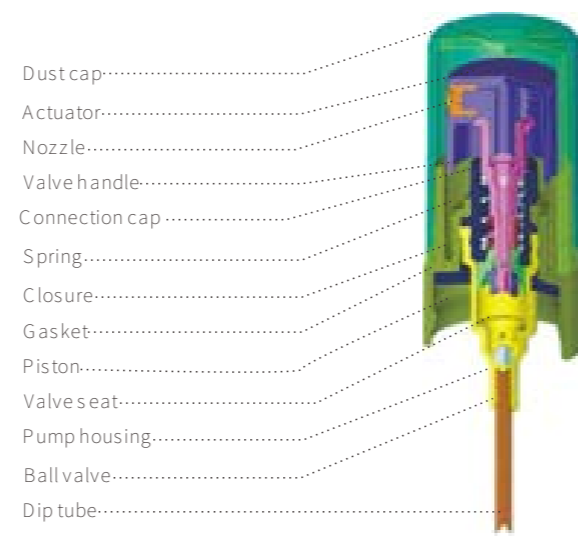

SPRAYA CTUATOR

OPTION



SPRAYER ACTUATOR LOTION ACTUATOR POUCH SPOUT

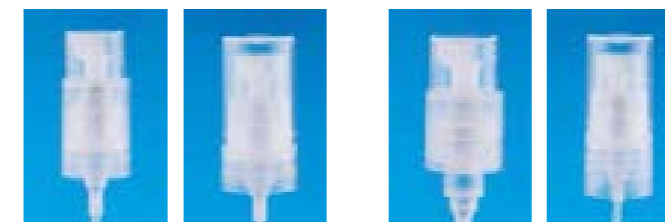

SNAP ON SCREW

All F= 6.1mm

	DIAMETER	DOSAGES	DIMENSIONS				HT VALUE		OPTION
			D	H	HC	HO	Sprayer	Lotion	Pouch Spout
CRIMP	11	0.06CC	12	5.05	12.2		19.9	19.9	
	13	0.06CC	14.7	5.8	12.2	23.7	19.9	19.9	
SCREW	M11	0.06CC	12	4.6	16.6		15.5	15.5	★
	13/415	0.06CC	14.7	10.3	12.2	23.7	19.9	19.9	

XXS-1



2ML 3ML 5ML

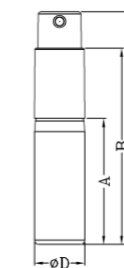

SNAP ON

Bottle Materials: Glass

CAPACITY	A	B	C	D
2ML	29.5	46	54.5	12
3ML	38.5	55	63.5	12
5ML	54.5	71	79.5	12



XXS-2

2ML 3ML 5ML

SCREW

Bottle Materials: HDPE, PP

CAPACITY	A	B	C	D
2ML	31.4	43	51.5	12
3ML	40.4	52	60.5	12
5ML	56.4	68	76.5	12



XXS-4

2ML 3ML 5ML

SCREW

Bottle Materials: PP

CAPACITY	A	B	C	D
5ML	57	69.5	90	15
8ML	93	105.5	126	15
10ML	115	127.5	148	15

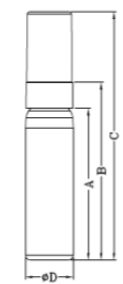

XXS-3

5ML 8ML 10ML

SNAPON

Bottle Materials: Glass

CAPACITY	A	B	C	D
5ML	46.4	54.4	75.9	15
8ML	67.4	75.4	96.9	15
10ML	82.4	90.4	111.9	15

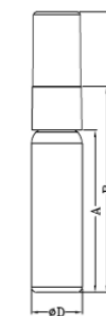

XXS-5

5ML 8ML 10ML

SCREW

Bottle Materials: Glass

CAPACITY	A	B	C	D
5ML	46.7	59.2	80.7	15
8ML	67.7	80.2	101.7	15
10ML	82.7	95.2	116.7	15



CAP

FLIP TOP



CP1001 24/415 CP1001 28/415 CP1004 18/410 CP1004 24/410 CP1004 28/415



CP1004 28/410 CP1003 24/410 CP1006 15/415 CP1006 24/410 CP1006 24/415

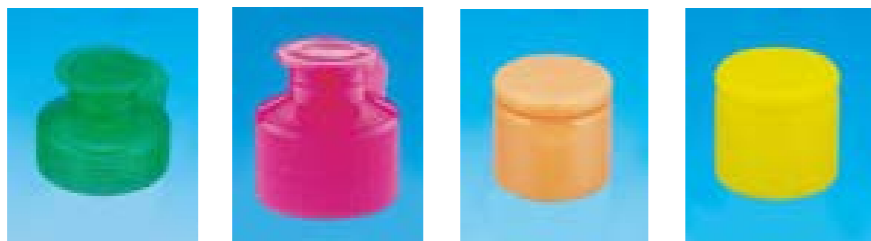

CP1007 28/400 CP1007 28/410 CP1002 24/410 CP1002 28/410

DISC TOP

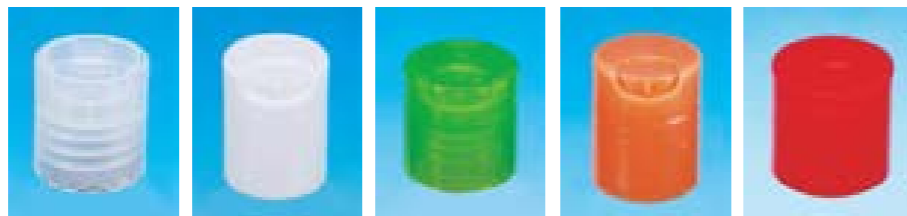

CP1020 20/410 CP1020 24/415 CP1020 24/410 CP1020 24/415 CP1020 28/410

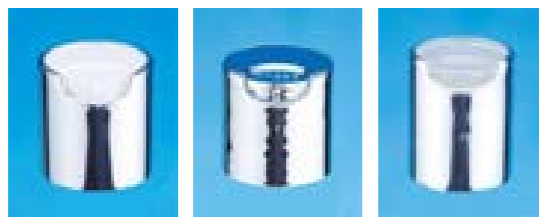

METAL COLLAR FOR OPTIONS

PUSH PULL



CP1033 24/410 CP1033 24/4104HOLES CP1033 28/410 CP1033 28/410(4HOLES)

TWIST



CP1038 20/410

CT



CP1041 20/410 CP1043 28/410 CP1043 24/410 WITH GASKET CP1043 24/410 CP1066 28/410



CP1070 M28 CP1070 M28 CP1055 16MM CP10552 22MM CP1058 22MM



CP1054 24/415 CP1065 24/415

CR (CHILD RESISTANT CAP)



CP1061 28/400 CP1061 28/410 GL28